

**TOMORROW'S
MANUFACTURING
LEADERSHIP
TODAY**

Technical Bulletin

Bulletin Number: 247 Revision Number: R-07

Release Date: November 2, 1982 Revision Date: June 15, 1993

SUBJECT: 1-1/4" DEEPER STACK SHIMMING AND ADJUSTMENT INSTRUCTIONS

MODELS: All 1-1/4" Deeper DNCB Venders prior to the Shimless Stack Vender.

REASON: To introduce a vender with a stack which is capable of vending 12oz. cans and 10oz. *PLB double depth.

SERIAL BREAK: 0001-2569CG to 0001-3098AN

SETTINGS:

1. Vender will be shipped from the factory set to vend 12oz. cans.
2. As shipped;
 - A. Two flat black shims (801,804,960.01) are installed per standard column.
 - B. One can shim (801,804,950.21) is installed per narrow column.
3. As shipped, the rear spacers will be in position #19 for 12oz. cans.
4.
 - A. The discharge port is set for 12oz. cans.
 - B. To vend the 10oz. returnable bottle reverse both the discharge member and the closure strip.
5. When the 10oz. *PLB bottle is used, load the bottles as follows:
 - A. Load the bottles crown (top) to the rear in standard columns.
 - B. Load the bottles heel to heel (bottom to bottom) in the narrow columns.

NOTE: *PLB stands for Pre-Labeled Bottle (glass).

Page 1 of 10

USE THIS CHART TO "SET-UP" and "SHIM" THE "1-1/4" DEEPER" MODEL VENDER.
 PRE-SHIMLESS STACK / PRE-SERIES 90, BEGINNING S/N 0001-2569CG to 0001-3098AN.

KIT #	LOADING DEPTH	PACKAGE	WIDE COLUMNS				ALL COLUMNS		NARROW COLUMNS				
			CAN RETAINER	SHIMS PER COLUMN	CAM SETTING	CAM FOR MOTOR	REAR SPACER LOCATION	SHIMS PER COLUMN	ROD IN	ROD IN	CAM SETTING	DIVIDER ANGLE	SCREWS
	2	12 oz CAN	1 PER COLUMN	2 BLACK	4 NOTCHES	0	HOLE 19	1 LEFT SHIM	-	-	#3	0	0
4	2	10 oz NR PLB (GLASS BOTTLE)	0	0	4 NOTCHES	0	HOLE 23	1 LEFT SHIM	-	-	#3	0	0
	2	10 oz RIMMLESS CAN (1/2 LITER)	1 PER COLUMN	6 BLACK	4 NOTCHES	0	HOLE 19	1 LEFT FORMED 2 FLAT SHIMS RIGHT SIDE	B	-	#3	0	0
2	1	10 oz COKE & DIET COKE RETURNABLE BOTTLES	0	4 BLACK, 2 GRAY	2 NOTCHES	0	HOLE 18	1 RIGHT FORMED, 4 FLAT SHIMS RIGHT SIDE	A*	C	#4	0	0
		10 oz TAB, DR PEPPER & DIET DR PEPPER RETURNABLE BOTTLES	0	4 BLACK, 2 GRAY	2 NOTCHES	0	HOLE 18	1 RIGHT FORMED, 4 FLAT SHIMS RIGHT SIDE	REAR A FRONT C+	-	#4	0	0
		10 oz SPRITE, FANTA, PEPSI, DIET PEPSI, 7-UP, & DIET RITE COLA RETURNABLE BOTTLES	0	4 BLACK, 2 GRAY	2 NOTCHES	0	HOLE 18	1 RIGHT FORMED, 4 FLAT SHIMS RIGHT SIDE	A*	C	#4	0	0
		10 oz ROYAL CROWN COLA RETURNABLE BOTTLE	0	4 BLACK, 2 GRAY	2 NOTCHES	0	HOLE 18	1 RIGHT FORMED, 4 FLAT SHIMS RIGHT SIDE	A	C	#4	0	0
2	1	10oz NR MOUNTAIN DEW & DR PEPPER PAPER LABEL GLASS BOTTLE (NON-RETURNABLE)	0	6 BLACK	2 NOTCHES	0	HOLE 12	1 RIGHT FORMED 4 FLAT SHIMS RIGHT SIDE	REAR A FRONT B	C	#4	0	0
		10oz NR COKE B, SPRITE B & MELLOW YELLOW GLASS BOTTLE (NON-RETURNABLE)	0	2 BLACK	2 NOTCHES	0	HOLE 12	1 RIGHT FORMED 2 FLAT SHIMS RIGHT SIDE	REAR A FRONT B	-	#4	0	0

@, * AND + SEE PAGE 4

USE THIS CHART TO "SET-UP" and "SHIM" THE "1-1/4" DEEPER" MODEL VENDER.
 PRE-SHIMLESS STACK / PRE-SERIES 90, BEGINNING S/N 0001-2569CG to 0001-3098AN.

KIT #	LOADING DEPTH	PACKAGE	WIDE COLUMNS				ALL COLUMNS	NARROW COLUMNS					
			CAN RETAINER	SHIMS PER COLUMN	CAM SETTING	CAM FOR MOTOR	REAR SPACER LOCATION	SHIMS PER COLUMN	ROD IN	ROD IN	CAM SETTING	DIVIDER ANGLE	SCREWS
	1	16 oz CAN	0	2 BLACK	2 NOTCHES	0	HOLE 9	DO NOT VEND IN NARROW COLUMNS	-	-	-	0	0
	1	12oz RETURNABLE BOTTLES	0	2 BLACK	2 NOTCHES	0	HOLE 18	DO NOT VEND IN NARROW COLUMNS	-	-	-	0	0
	1	16oz RETURNABLE BOTTLES	0	2 BLACK	2 NOTCHES	0	HOLE 23	DO NOT VEND IN NARROW COLUMNS	-	-	-	0	0
	WIDE COLUMNS 2 NARROW COLUMNS 1	10 oz PLB SPECIALS WIDE MOUTH JUICE BOTTLES VERY FINE, FARMFIELD, LINCOLN, JUICE BOWL & MOTTS	0	1 SPRING SHIM EACH SIDE, BEND SOLD OUT PADDLES DOWN	4 NOTCHES	0	WIDE COLUMN HOLE 23 AT TOP, BOTTOM ALL THE WAY BACK BEYOND HOLES. NARROW COLUMN HOLE 8	0 VEND SINGLE IN NARROW COLUMNS	-	-	#4	0	0
	1	6-1/2oz & 7oz Returnable Bottles	0	1 LEFT HAND WALL 1 RIGHT HAND WALL	2 NOTCHES	0	HOLE #13	1 RIGHT FORMED 4 FLAT SHIMS RIGHT SIDE	REAR A FRONT C	-	#4	0	0

@, * AND + SEE PAGE 4

1. Where the symbols *, + and @ are used refer to the following:
(Use plastic tubing only where called out.)
 - * Where the symbol * appears on page 2 or page 3, place the 10-3/4" long (9/32" ID 3/8" OD) yellow plastic tube over the rod.
 - + Where the + appears on page 2 or page 3, place the 10-3/4" long (9/32" ID 7/16" OD) red plastic tube over the rod.
 - @ Where the @ appears on page 2 or page 3, place the 10-3/4" long (9/32" ID 17/32" OD) white plastic tube over the rod.
2. Where Rear A/Front C appears on page 2 or page 3, it means the rod is installed (spring end first) in A (hole) at the rear of the vend rotor - the front end of the same rod is installed in C (hole) at the front of the vend rotor.

12oz CANS

From Page 2 Consists Of:

Per Vender		Shim Kit					
5	6	6	8	10			
Standard Columns	Standard Columns	Column Dual	Column Dual	Column Dual			
0	0	3	4	9	801,804,950.21	Can Shim Left	Narrow Column
10	12	6	8	2	801,804,960.01	Flat Black Shim	Wide Column

Kit 2

From Page 2 Consists Of:

Per Vender		Rod & Shim Kit					
5	6	6	8	10			
Standard Columns	Standard Columns	Column Dual	Column Dual	Column Dual			
20	24	12	16	4	801,804,960.01	Flat Black Shim	Wide Column
10	12	6	8	2	801,805,120.01	Thin Gray Shim	Wide Column
0	0	3	4	9	801,805,230.01	Right Formed Shim	Narrow Column
0	0	12	16	36	901,303,630.11	Flat Shims	
0	0	6	8	18	267,012,300.03	Rod & Spring Assy.	
0	0	3	4	9	901,901,950.01	Tube-Yellow Plastic	
0	0	1	1	2	901,902,000.01	Tube-Red Plastic	
1	1	1	1	1	901,000,190.02	Crown Puller	Per Vender
3	3	3	3	3	901,201,480.01	Screw (10-32 x 3/8)	
3	3	3	3	3	900,800,650.01	Nut	

Accessories: When ordering the Rod and Shim Kit above, also order a crown chute and a crown catcher if vender does not have them factory installed.

16oz Can

From Page 2 Consists Of:

Per Vender

		Shim Kit		
5	6	6	8	10
Standard	Standard	Column	Column	Column
<u>Columns</u>	<u>Columns</u>	<u>Dual</u>	<u>Dual</u>	<u>Dual</u>
10	12	6	8	2

801,804,960.01 Black Shim Wide Columns Only.

DO NOT VEND IN NARROW COLUMNS.

Kit 4

From Page 2 Consists Of:

Per Vender

		Shim Kit		
5	6	6	8	10
Standard	Standard	Column	Column	Column
<u>Columns</u>	<u>Columns</u>	<u>Dual</u>	<u>Dual</u>	<u>Dual</u>
0	0	3	4	9

801,805,220.01 10oz PLB Shim (Plastic) Left Narrow Columns Only.

Or

267,010,230.03 10oz PLB Shim (Metal) Left.

10oz PLB Specials (Wide Mouth Juice Bottles)

From Page 3 Consists Of:

Per Vender

		Shim Kit		
5	6	6	8	10
Standard	Standard	Column	Column	Column
<u>Columns</u>	<u>Columns</u>	<u>Dual</u>	<u>Dual</u>	<u>Dual</u>
5	6	3	4	1

B4090.06
Right Spring Shim

Wide Column

5	6	3	4	1
---	---	---	---	---

B4080.06
Left Spring Shim

10oz Can (Rimless)

From Page 2 Consists Of:

Per Vender

		Shim Kit		
5	6	6	8	10
Standard	Standard	Column	Column	Column
<u>Columns</u>	<u>Columns</u>	<u>Dual</u>	<u>Dual</u>	<u>Dual</u>
30	36	18	24	6

801,804,960.01
Black Shim

Wide Column

0	0	3	4	9
---	---	---	---	---

267,010,150.13
Left Formed 10oz Shim

Narrow Column

10	12	6	8	18
----	----	---	---	----

901,303,630.11
Right Hand Flat Shim

6 1/2 oz and 7 oz Returnable Bottle
 From Page 3 Consists Of:

Per Column Wide

QTY.	PART NUMBER	DESCRIPTION	VENDER PART USED IN
1	275,010,500.03	Left Hand Wall	56 5/16" High 1 1/4" Deeper Venders
1	275,010,600.03	Right Hand Wall	56 5/16" High 1 2/4" Deeper Venders
1	276,010,300.03	Left Hand Wall	66 5/16" High 1 1/4" Deeper Venders
1	276,010,400.03	Right Hand Wall	66 5/16" High 1 1/4" Deeper Venders
1	270,010,200.03	Left Hand Wall	72" High 1 1/4" Deeper Venders
1	270,010,300.03	Right Hand Wall	72" High 1 1/4" Deeper Venders
1	267,013,400.03	Left Hand Wall	79 1/2" High 1 1/4" Deeper Venders
1	267,013,300.03	Right Hand Wall	79 1/2" High 1 1/4" Deeper Venders

Per Column Narrow

QTY.	PART NUMBER	DESCRIPTION
1	801,805,230.01	Right Formed Shim
4	901,303,630.11	Flat Shim
1	267,012,300.03	Rod & Spring Assembly

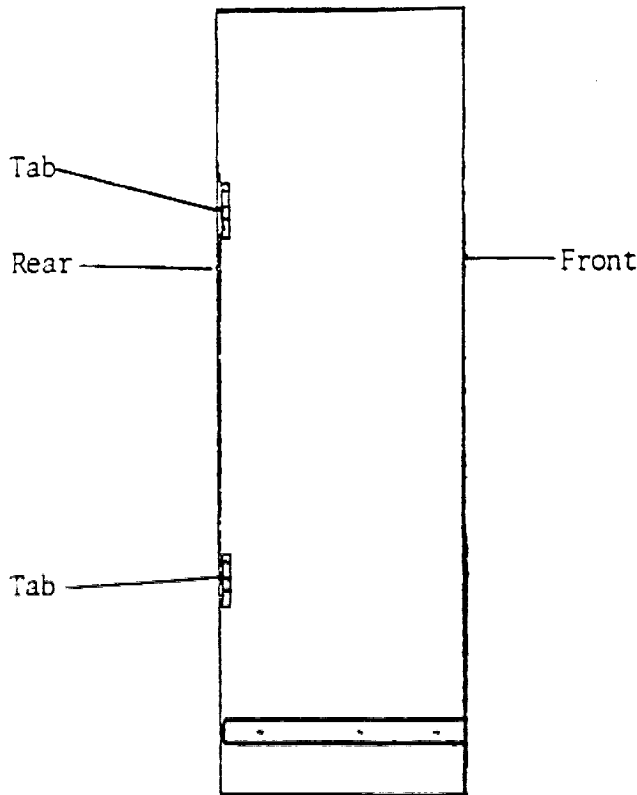

Wall-Left Side

To install wall, align the tabs with the existing slots in the column wall and drop the wall in position. Wall left side shown in figure to the left.

The shims and rods shown here are for reference only, i.e., to identify these parts. Refer to the chart on pages 2 and 3 for the shims and rods required per column, for vend cam adjustment on the vend motors for both wide and narrow columns for vending different products.

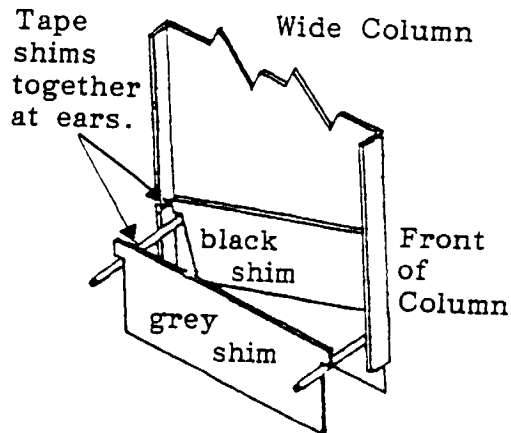
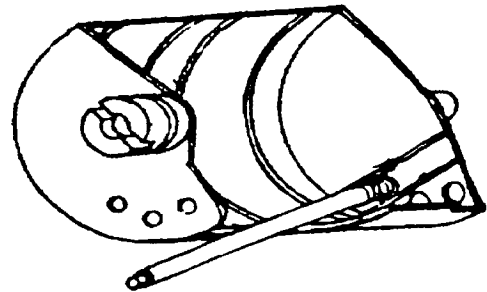
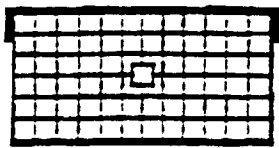

Figure 1



Rotor
#801,201,060.01
Rod & Spring Assembly
#267,012,300.03

Figure 2



Black Shim
#801,804,960.01

Figure 3

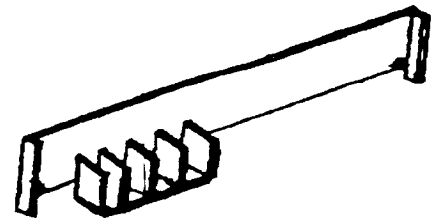

12oz. Can Shim (plastic)
#801,804,950.21

Figure 4

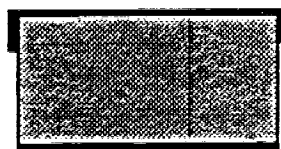

Grey Shim
#801,805,120.01

Figure 5

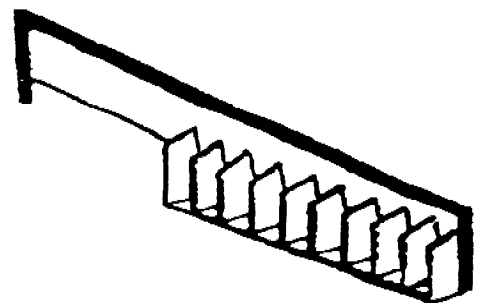

10oz. Ret. Bottle Shim (plastic)
#801,805,230.01

Figure 6

The shims and rods shown here are for reference only, i.e., to identify these parts. Refer to the chart on pages 2 and 3 for the shims and rods required per column, for vend cam adjustment on the vend motors for both wide and narrow columns for vending different products.

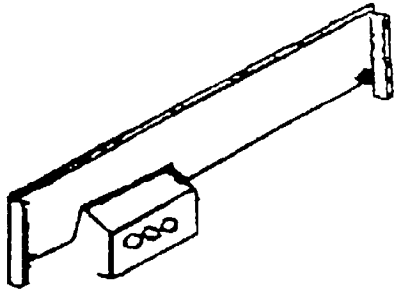

10oz. PLB Shim (Metal)
#267,010,230.03
Figure 7

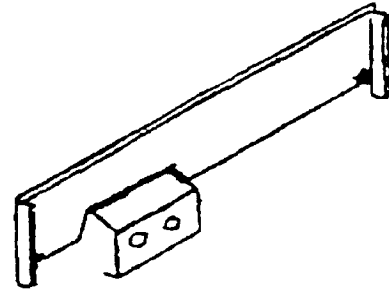

10oz. Rimmed Can Shim
#267,010,150.13
Figure 8

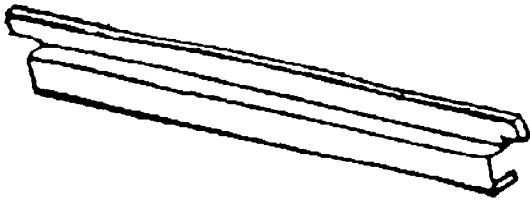

Metal Formed Shim
#267,010,130.03
Figure 9



Flat Shim (Metal)
#901,303,630.11
Figure 10

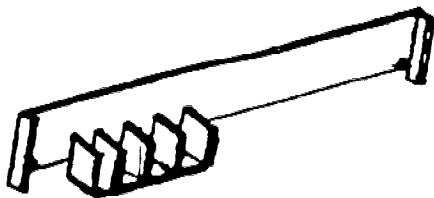

10oz. PLB Shim (Plastic)
#801,805,220.01
Figure 11

REAR SPACER ADJUSTMENT HOLES LOCATED IN THE SIDEWALLS OF THE STACKS.

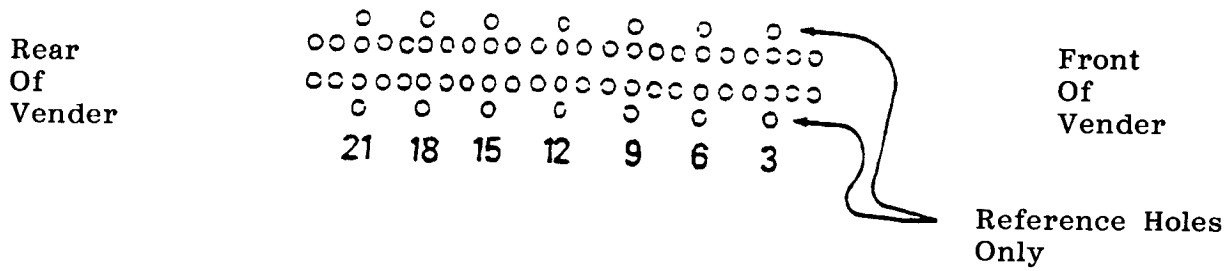

Figure 7

WIDE COLUMN
PACKAGE LOADING

1-1/4" DEEPER STACK

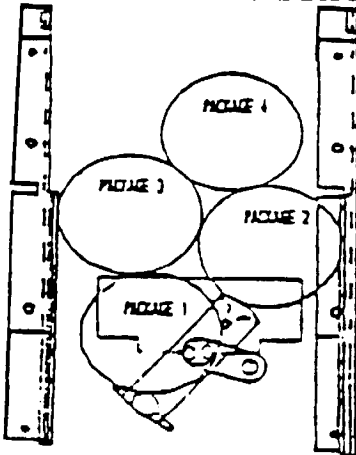

Figure 8

- A. Position oscillator as shown. Load packages number 1, 2, 3, & 4 as shown in the front and rear. Front and rear must be loaded evenly.

IMPORTANT: When vending bottles, load bottles with caps toward the rear of vender. When a column is sold out, load first 2 bottles heel down, and crown up at approximately 45 degrees. Then release bottle to lay in a horizontal position.

NARROW COLUMN
PACKAGE LOADING

1-1/4" DEEPER STACK

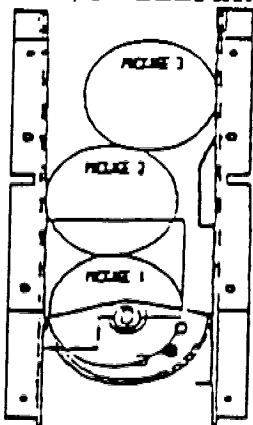

Figure 9

- A. Position rotor as shown. Load packages 1, 2, and 3 as shown, in both the front and rear of column. Front and rear must be loaded evenly.

IMPORTANT: When using bottles, load bottles heel to heel (bottom to bottom).

SUBJECT: CAM ADJUSTMENT ON NARROW COLUMN VEND MOTORS

MODELS: All DNCB 1-1/4" Deeper Venders Prior To Series 90.

1. For packages that can be vended double depth, secure the screw in the adjustable cam at position #3, see figure 1.
2. For packages that must be vended single depth, secure the screw in the adjustable cam at position #4, see figure 1.
3. If when vending the 10oz. PLB in the narrow column, the need arises for the vend motor to run longer, secure the screw in the adjustable cam at position #2, see figure 1.

PRE-SERIES 90



Figure 1

SUBJECT: CAM ADJUSTMENT ON WIDE COLUMN VEND MOTORS

MODELS: All DNCB 1-1/4" Deeper Venders

SETTING: Set at 2 notches - For Single Depth Package
Set at 4 notches - For Double Depth Package
(See figure 2.)

PRE-SERIES 90

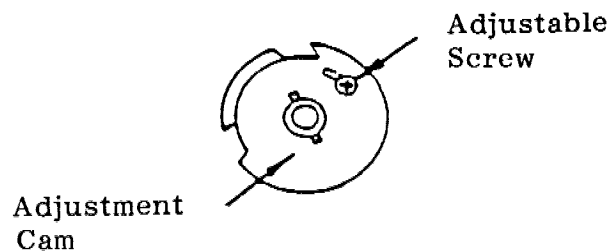

Figure 2